

twareLAB

4CH S2E Module

Datasheet Ver1.2

Contents

1	Introduction	3
1.1	Key Features	3
1.2	Product Specifications.....	3
2	Hardware Specification.....	4
2.1	Description	4
2.1.1	TW100MJ.....	4
2.1.2	TW100XR.....	4
2.1.3	TW100PC.....	5
2.2	Dimension.....	5
2.2.1	TW100MJ.....	5
2.2.2	TW100XR.....	6
2.2.3	TW100PC.....	6
2.3	Pin Map.....	7
2.3.1	TW100MJ / TW100XR	7
2.3.2	TW100PC.....	9
2.4	Reference Schematic	11
3	History	12

1 INTRODUCTION

1.1 KEY FEATURES

- 4 Port Serial-to-Ethernet
- Support DHCP IP Acquisition
- Support DNS Query
- Support NTP Time Query
- Support Time Zone Setting
- TCP/UDP Data Communication
- Ethernet Data Packing Option
- Support Up to 3Mbps UART Baud Rate

1.2 PRODUCT SPECIFICATIONS

Specification	
MCU	STM32F405RGT6 (RAM: 192Kbyte, FLASH: 1Mbyte)
LAN	W5500 (10/100Mbps Ethernet)
UART	4 Port (3.3V TTL Level)
Console Port	Supported
Dimension	TW100MJ: 48.26(W)x61.4(H)x22(D), TW100XR: 48.26(W)x58.00(H)x15(D)
Connector	2.54mm Pitch Pin Header. J5: 2x14, J6: 1x14
Input Power	DC 3.3V
Power Dissipation	Typical: 100mA, Peak: 150mA
Temperature	Operation: 0°C ~ +70°C, Storage: -40°C ~ +85°C
Humidity	10 ~ 80%

2 HARDWARE SPECIFICATION

2.1 DESCRIPTION

2.1.1 TW100MJ

- RJ45 embedded (Ethernet Transformer inside)
- 2.54 pitch pin header interface (42 pins)

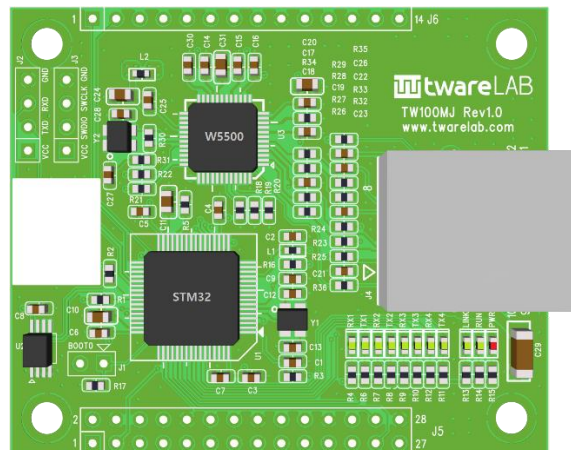

2.1.2 TW100XR

- Ethernet Transformer embedded
 - RJ45 is needed on the customer board
- 2.54 pitch pin header interface (42 pins)

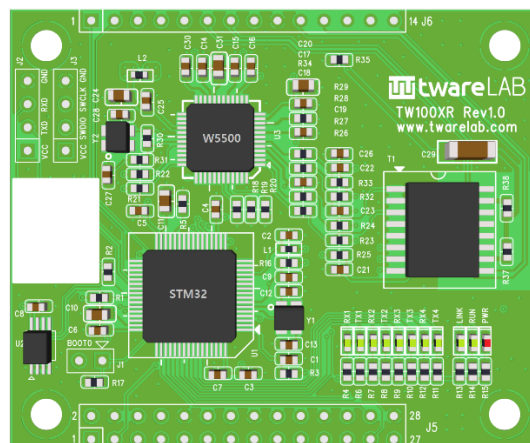

2.1.3 TW100PC

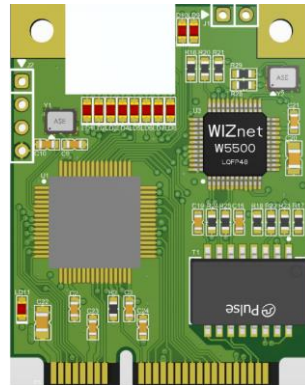

- Ethernet Transformer embedded
 - RJ45 is needed on the customer board
- miniPCI interface (52 pins)

2.2 DIMENSION

2.2.1 TW100MJ

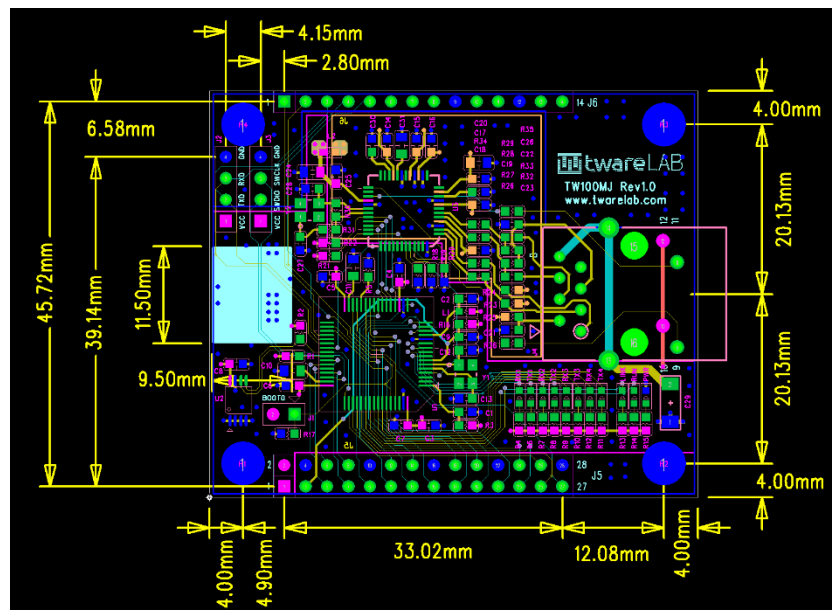

2.3 PIN MAP

2.3.1 TW100MJ / TW100XR

2.3.1.1 Header Pin Layout

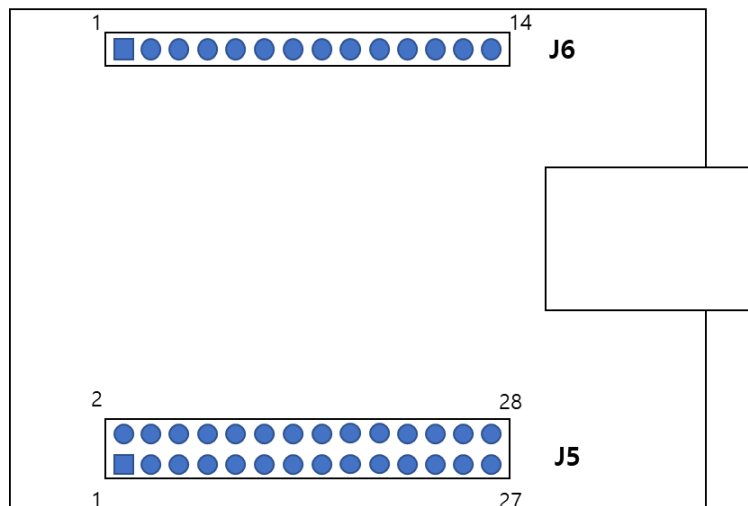

2.3.1.2 J5 Connector

Pins	Signal	I/O	Description
1	VCC_3.3	S	Power 3.3V
2	VCC_3.3	S	Power 3.3V
3	/RESET	I	Board Rest, Active Low
4	GND	S	Ground
5	UART1_RX	I	3.3V TTL Level.
6	UART1_CTS	I	3.3V TTL Level
7	UART1_TX	O	3.3V TTL Level
8	UART1_RTS	O	3.3V TTL Level
9	STATUS_1	O	1: TCP Disconnected, 0: TCP Connected
10	GND	S	Ground
11	UART2_RX	I	3.3V TTL Level.
12	UART2_CTS	I	3.3V TTL Level
13	UART2_TX	O	3.3V TTL Level
14	UART2_RTS	O	3.3V TTL Level
15	STATUS_2	O	1: TCP Disconnected, 0: TCP Connected
16	GND	S	Ground
17	UART3_RX	I	3.3V TTL Level.
18	UART3_CTS	I	3.3V TTL Level
19	UART3_TX	O	3.3V TTL Level

20	UART3_RTS	O	3.3V TTL Level
21	STATUS_3	O	1: TCP Disconnected, 0: TCP Connected
22	GND	S	Ground
23	UART4_RX	I	3.3V TTL Level.
24	UART4_CTS	I	3.3V TTL Level
25	UART4_TX	O	3.3V TTL Level
26	UART4_RTS	O	3.3V TTL Level
27	STATUS_4	O	1: TCP Disconnected, 0: TCP Connected
28	GND	S	Ground

2.3.1.3 J6 Connector

Pins	Signal	I/O	Description
1	SW_INPUT	I	SW Input for software reset. Internal Pull-Up. Active Low.
2	HW_TRIGGER	I	AT Command Mode Activate. Active Low. Internal Pull-Up
3	Console_TX	O	
4	Console_RX	I	
5	BOOT	I	Active High. Pin for STM32 Boot Mode
6	MDI_TXM	O	Differential Signal to RJ45. Available for only TW100XR
7	MDI_TXP	O	Differential Signal to RJ45. Available for only TW100XR
8	NC		
9	GND	S	
10	MDI_RXM	I	Differential Signal to RJ45. Available for only TW100XR
11	MDI_RXP	I	Differential Signal to RJ45. Available for only TW100XR
12	AGND	S	Analog Ground
13	/LINK_LED	O	Active Low. LINK LED indicator. Available for only TW100XR
14	/ACT_LED	O	Active Low. ACT LED indicator. Available for only TW100XR

2.3.2 TW100PC

2.3.2.1 miniPCI Layout

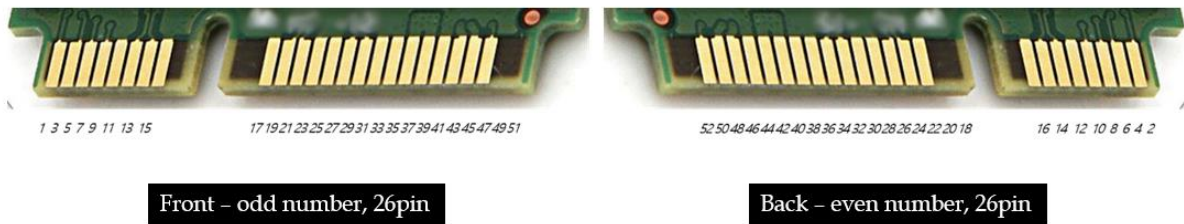

2.3.2.2 miniPCI Connector

Pins	Signal	I/O	Description
1	VCC_3.3	S	Power 3.3V
2	GND	S	Ground
3	NC		
4	NC		
5	NC		
6	NRST	I	Board Rest, Active Low
7	UART2_CTS	I	3.3V TTL Level
8	UART2_RTS	O	3.3V TTL Level
9	UART2_TX	O	3.3V TTL Level.
10	UART2_RX	I	3.3V TTL Level
11	VCC_3.3	S	Power 3.3V
12	GND	S	Ground
13	STATUS_1	O	1: TCP Disconnected, 0: TCP Connected
14	STATUS_2	O	1: TCP Disconnected, 0: TCP Connected
15	STATUS_3	O	1: TCP Disconnected, 0: TCP Connected
16	STATUS_4	S	1: TCP Disconnected, 0: TCP Connected
17	UART3_TX	O	3.3V TTL Level.
18	UART3_RX	I	3.3V TTL Level
19	NC		
20	UART3_CTS	I	3.3V TTL Level.
21	UART3_RTS	O	3.3V TTL Level
22	SW_Input	I	SW Input for software reset. Internal Pull-Up. Active Low.
23	VCC_3.3	S	Power 3.3V
24	GND	S	Ground
25	Console_TX	O	3.3V TTL Level
26	Console_RX	O	3.3V TTL Level

27	NC		
28	NC		
29	UART1_TX	O	3.3V TTL Level.
30	UART1_RX	I	3.3V TTL Level
31	UART1_CTS	I	3.3V TTL Level.
32	UART1_RTS	O	3.3V TTL Level
33	NC		
34	NC		
35	UART4_RTS	O	3.3V TTL Level.
36	UART4_TX	O	3.3V TTL Level
37	UART4_RX	I	3.3V TTL Level.
38	UART4_CTS	I	3.3V TTL Level
39	HW_TRIGGER	I	AT Command Mode Activate. Active Low. Internal Pull-Up
40	NC		
41	NC		
42	NC		
43	VCC_3.3	S	Power 3.3V
44	GND	S	Ground
45	/LINK_LED		Active Low. LINK LED indicator
46	/ACT_LED		Active Low. ACT LED indicator
47	MDI_RXN		Differential Signal to RJ45
48	MDI_TXN		Differential Signal to RJ45
49	MDI_RXP		Differential Signal to RJ45
50	MDI_TXP		Differential Signal to RJ45
51	NC		
52	AGND		

2.4 REFERENCE SCHEMATIC

This is only for TW100XR and TW100PC.

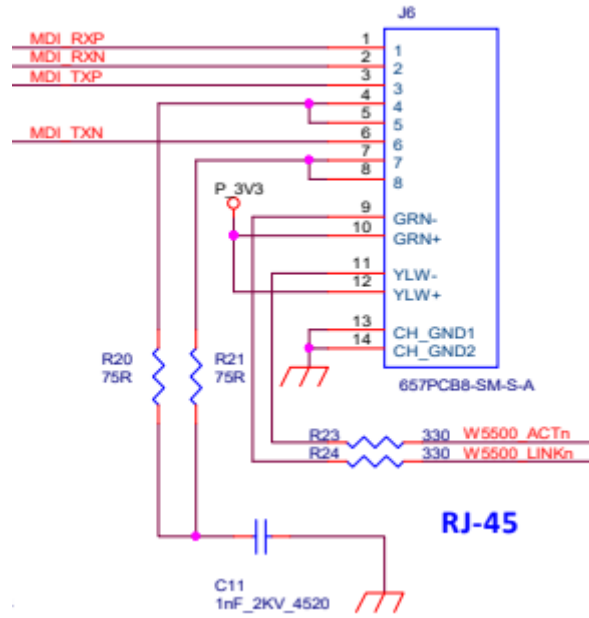

3 HISTORY

Date	Description
2022-11-02	V1.0 First Released
2023-01-27	V1.1 Add 2.5 Reference Schematic
2023-11-25	V1.2 STATUS pins, SW_Input pin, Boot pin description updated